

5. 外観図

エルソニックメーター

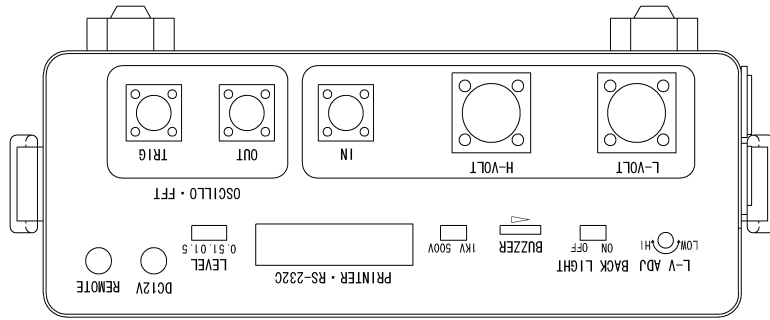

背面

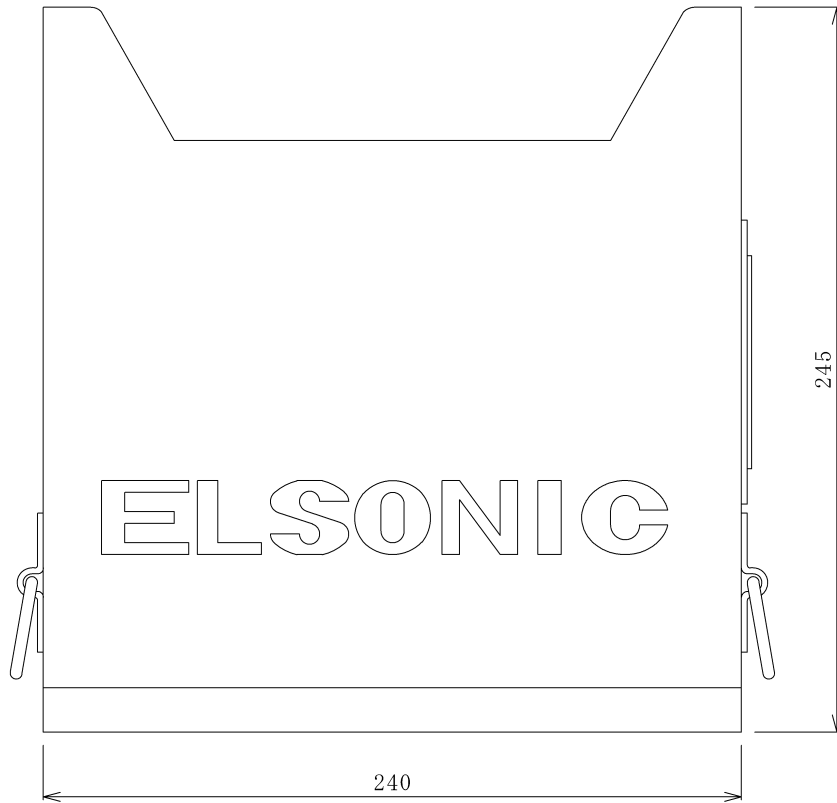

上面

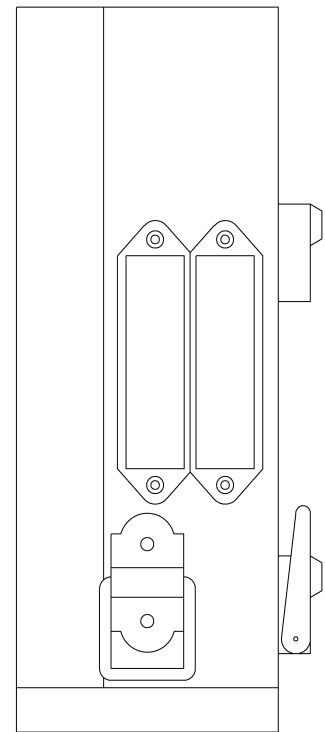

側面 (右)

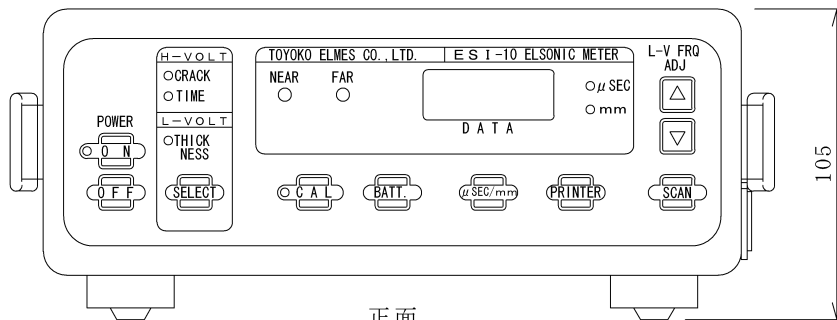

正面

単位 (mm)

ひび割れ・音速センサー

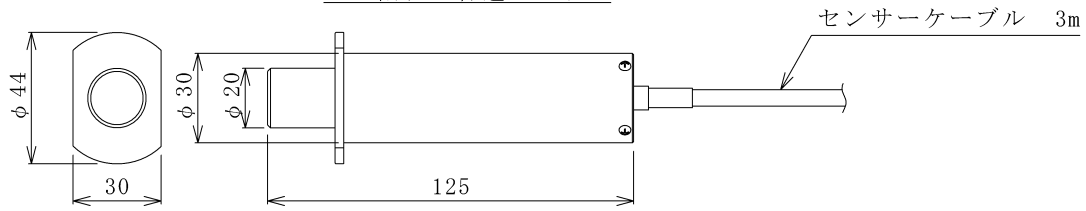

ひび割れ小型センサー

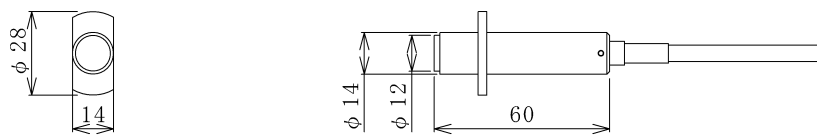

送信側コネクタ (N型)

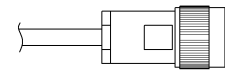

ひび割れ強力センサー

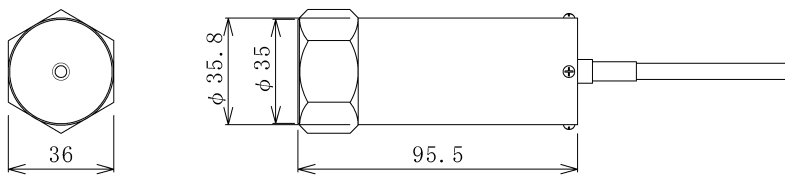

受信側コネクタ (BNC型)

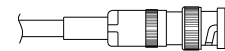

厚さセンサー

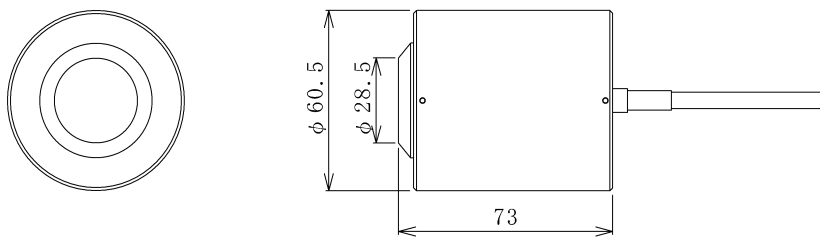

厚さ小型センサー

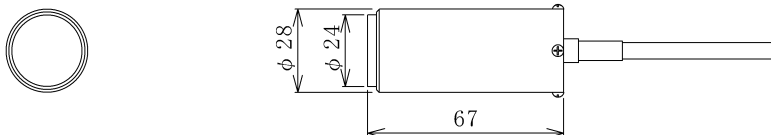

単位 (mm)

繰り返し加振器

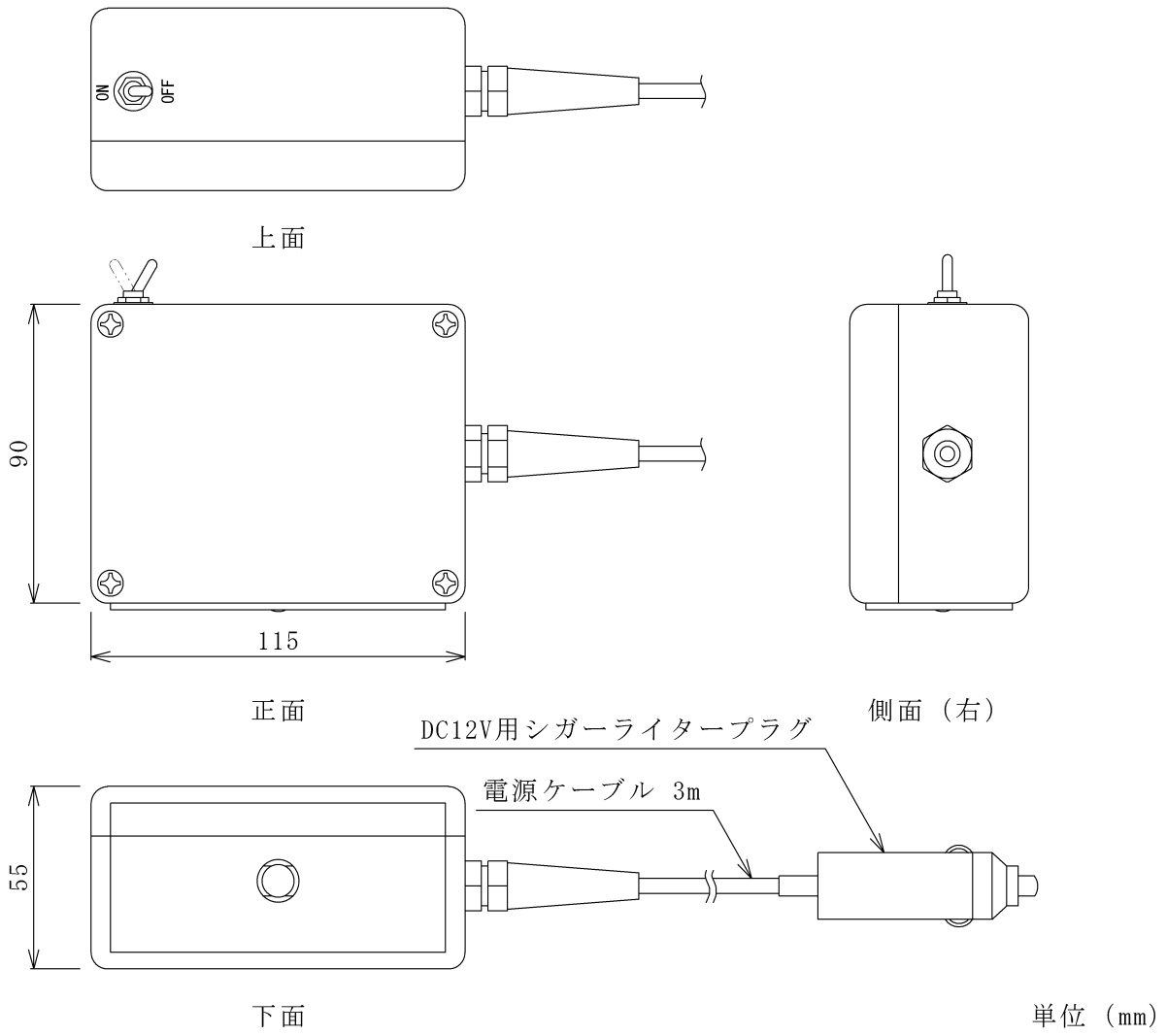

FFTアナライザー

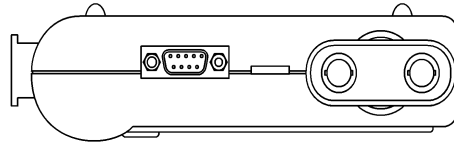

上面

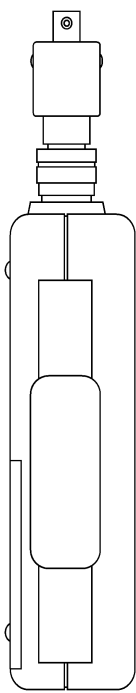
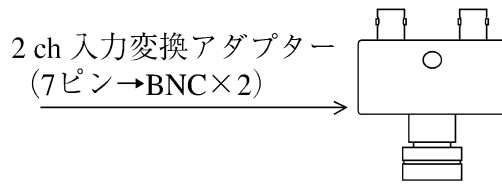

側面 (左)

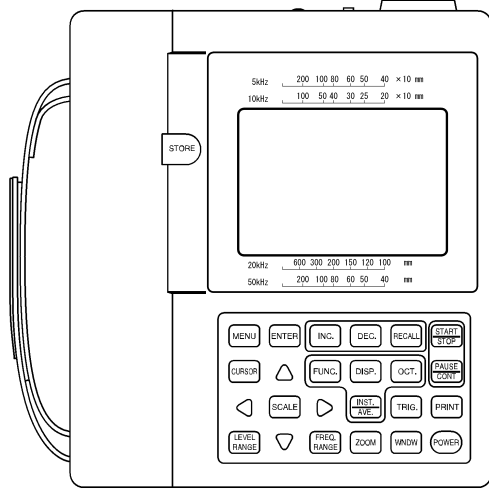

156

正面

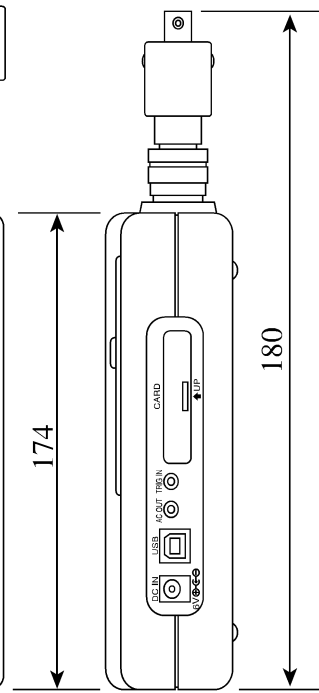

側面 (右)

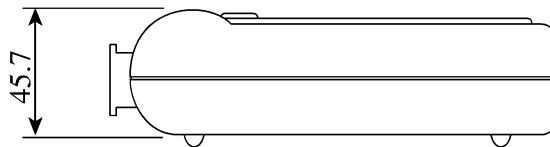

下面

単位 (mm)